

# ZILBRYSQ<sup>®</sup>

(zilucoplan) Injection

## Step-by-Step Injection Guide





## **INSTRUCTIONS FOR USE**

**ZILBRYSQ® (ZIL-brisk)  
(zilucoplan)**

injection, for subcutaneous use  
Single-Dose Prefilled Syringe

**This Instructions for Use contains  
information on how to inject ZILBRYSQ.**

## Understanding Your ZILBRYSQ Prefilled Syringe

Read this Instructions for Use before using the ZILBRYSQ prefilled syringe. This information does not take the place of talking to your healthcare provider about your medical condition or treatment. See the Medication Guide that comes with ZILBRYSQ for important information.

Your healthcare provider should show you how to prepare and inject ZILBRYSQ prefilled syringe properly before you use it for the first time. Do not inject yourself or someone else until you have been shown how to inject ZILBRYSQ correctly.

Keep this Instructions for Use and refer to it as needed until you have used all of the ZILBRYSQ prefilled syringes in the packaging.

For general questions or help, please call your healthcare provider or UCBCares at **1-844-599-CARE** (2273).

## How Should I Store ZILBRYSQ Prefilled Syringes?



Store ZILBRYSQ prefilled syringes in a refrigerator between 36°F to 46°F (2°C to 8°C) until the expiration date on the carton. **Do not freeze ZILBRYSQ.**



ZILBRYSQ prefilled syringes may be stored at room temperature up to 86°F (30°C) in the original carton for a single period of up to 3 months. Write the date you removed the prefilled syringes from the refrigerator in the space provided on the carton. After ZILBRYSQ prefilled syringes have been stored at room temperature, do not place them back in the refrigerator. Throw them away if not used within 3 months or if the expiration date has passed, whichever occurs first.

- Keep the ZILBRYSQ prefilled syringes in the original carton before use.
- **Keep ZILBRYSQ prefilled syringes and all medicines out of the reach of children.**



# Important Information You Need

- **Do not** use ZILBRYSQ if the expiration date on the packaging has passed or the carton seals have been broken.
- **Do not** reuse the ZILBRYSQ prefilled syringe. The prefilled syringe is for 1-time (single use) only. You may get an infection.
- **Do not** inject ZILBRYSQ more than 1 time per day.
- **Do not** miss any doses of ZILBRYSQ. If you miss your ZILBRYSQ dose, inject a dose as soon as possible. Then, inject the next dose at your scheduled time. Do not inject more than 1 dose each day.
- **Do not** use the ZILBRYSQ prefilled syringe if it has been dropped.
- **Do not** remove the needle cap from the ZILBRYSQ prefilled syringe until you are ready to inject.
- **Do not** insert the needle into the skin more than 1 time because this may bend or break the needle, causing trauma to the tissue.
- **Do not** pull back on the ZILBRYSQ prefilled syringe plunger head at any time because this can break the prefilled syringe.
- **Do not** touch the needle guard activation clips at any time because this can cause the early activation of the needle guard.

# to Know Before You Inject ZILBRYSQ

## ZILBRYSQ Prefilled Syringe Guide to Parts (Figure A):

### Before use:

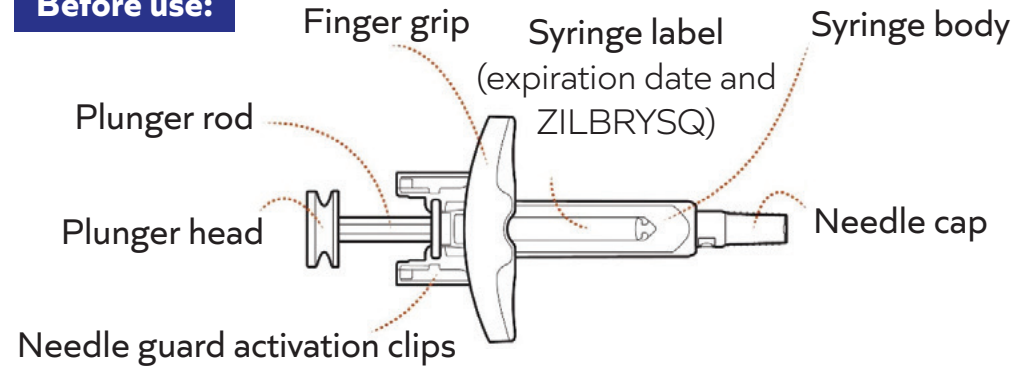

### After use:

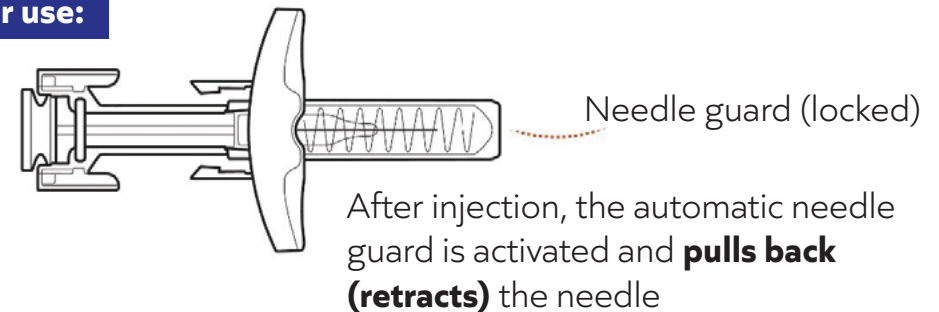

Figure A

# Preparing for Injection

## Step 1: Take out the ZILBRYSQ prefilled syringe

If the ZILBRYSQ prefilled syringes are stored in the refrigerator:

- Take the ZILBRYSQ prefilled syringes carton out of the refrigerator and remove 1 prefilled syringe from the carton.  
**Grasp the prefilled syringe body.** Carefully lift the prefilled syringe straight up out of the tray (**Figures B.1 and B.2**). Put the rest of the prefilled syringes in the carton back in the refrigerator.
- Before you inject ZILBRYSQ, let the prefilled syringe warm up to room temperature on a clean flat surface **for 30 to 45 minutes**. This will help to reduce discomfort when injecting.
- Do not warm the ZILBRYSQ prefilled syringe in any other way (for example in a microwave, in hot water, or in direct sunlight).
- Do not remove the needle cap from the prefilled syringe until you are ready to inject.

If the ZILBRYSQ prefilled syringes are stored at room temperature:

- Remove 1 ZILBRYSQ prefilled syringe from the carton.  
**Grasp the prefilled syringe body.** Carefully lift the prefilled syringe straight up out of the tray (**Figures B.1 and B.2**). Any remaining prefilled syringes in the carton should not be placed in the refrigerator after it has been stored at room temperature.

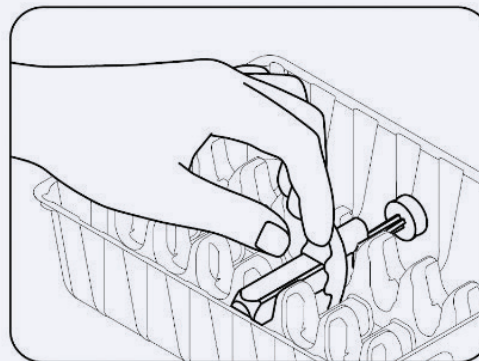

Figure B.1

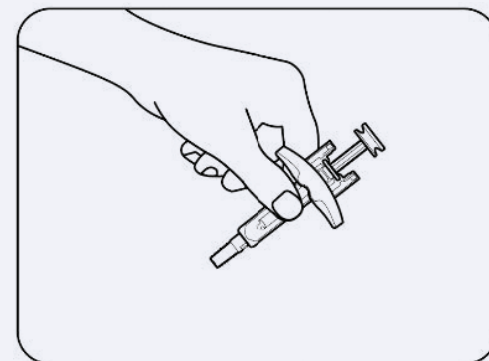
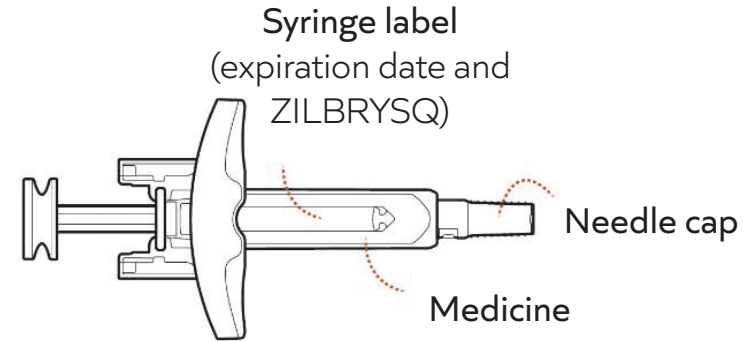

Figure B.2

## Step 2: Inspect the ZILBRYSQ prefilled syringe

- Check the prefilled syringe for damage (**Figure C**).
- **Do not** use if any part of the prefilled syringe appears to be cracked, leaking, or broken.
- Check that the needle cap is not cracked or broken and attached to the prefilled syringe (**Figure C**).
- **Do not** use if the needle cap is missing or not securely attached.
- Check the expiration date and medicine name (ZILBRYSQ) on the prefilled syringe label (**Figure C**).
- **Do not** use if the expiration date printed on the prefilled syringe has passed.
- **Do not** use if the word ZILBRYSQ does not appear on the prefilled syringe.

- Check the dose appearing on the label (**Figure C**) and make sure it matches your prescribed dose.
- **Do not** use if the dose does not match your prescribed dose.
- Check the medicine inside the prefilled syringe (**Figure C**). The medicine should be clear to almost clear and colorless. It is normal to see air bubbles in the prefilled syringe.
- **Do not** use if the medicine is cloudy, discolored, or contains floating particles.



**Figure C**

### Step 3: Gather Supplies

Wash your hands with soap and water and dry them with a clean towel.

Gather the following supplies on a clean, flat surface (**Figure D**):

- 1 ZILBRYSQ prefilled syringe
- 1 alcohol wipe (not supplied)
- 1 cotton ball or gauze pad (not supplied)
- 1 adhesive bandage (not supplied)
- 1 sharps disposal or puncture-resistant container (not supplied).

See Step 12 for instructions on throwing away the syringe.

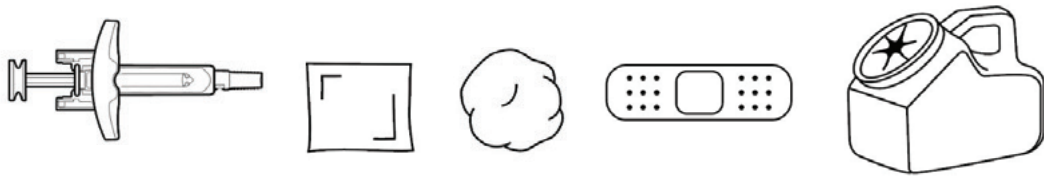

**Figure D**

### Step 4: Choose your injection site

Choose an injection site from the following areas (**Figures E.1** and **E.2**):

- The stomach (abdomen), except for the 2-inch area around the belly button (navel) (**Figure E.1**)
- The front of the thighs (**Figure E.1**)
- The back of the upper arms (only if someone else is giving you the injection) (**Figure E.2**)



**Figure E.1**  
abdomen and thighs

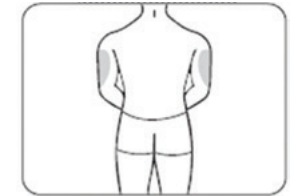

**Figure E.2**  
upper arms

Choose a different site each time you give yourself an injection. If you want to use the same injection site, make sure it is at least 1-inch from a spot you used before.

**Do not** inject ZILBRYSQ into an area that is red, tender, bruised, swollen, hard or that has scars or stretch marks.

## Step 5: Clean your injection site

Clean the injection site using an alcohol wipe (**Figure F**). Let the skin dry for 10 seconds before injecting.

**Do not** touch the injection site again before giving your injection.

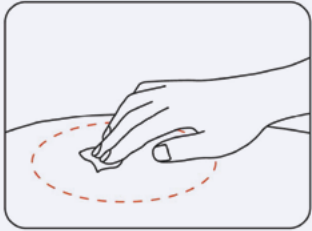
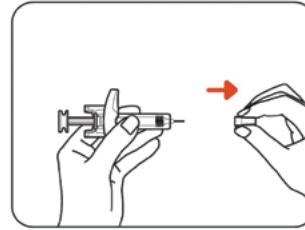

**Figure F**

## Injecting the Medicine

### Step 6: Remove the needle cap

Hold the body of the ZILBRYSQ prefilled syringe with one hand and pull the needle cap straight off with your other hand (**Figure G**).



**Figure G**

**Throw away (discard) the needle cap into your household trash or a sharps disposal container.**

**Do not** touch the needle or let it touch anything.

**Do not** recap the needle at any time to avoid injury.

**Do not** try to remove any air bubbles from the ZILBRYSQ prefilled syringe. Air bubbles will not affect your dose and will not harm you. This is normal. You can continue to take your injection.



## Step 7: Pinch your injection site

Use your other hand to pinch the area of cleaned skin and hold it firmly (**Figure H**).

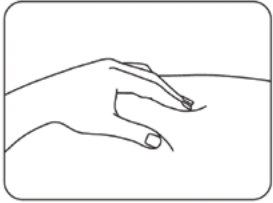

Figure H

## Step 8: Insert the needle

Insert the entire needle into the pinched skin at a 45° to 90° angle. When the needle is fully inserted, hold the ZILBRYSQ prefilled syringe in place (**Figure I**).

**Do not** pull back on the plunger head at any time because this could break the prefilled syringe.

**Do not** touch the needle guard activation clips.

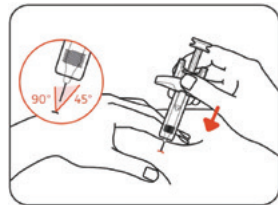

Figure I

## Step 9: Release the pinched skin

When the needle is fully inserted, hold the ZILBRYSQ prefilled syringe in place and release the pinched skin (**Figure J**).

**Do not** reinsert the needle into the skin if the needle is pulled out when releasing the skin. If this happens, safely throw away (dispose of) the syringe in a sharps disposal container and get a new ZILBRYSQ prefilled syringe to give the injection.

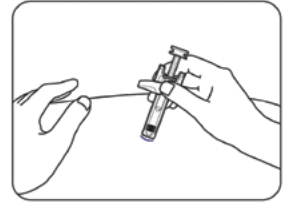

Figure J

## Step 10: Inject the medicine

Push the plunger head all the way down while holding onto the finger grip to inject all the medicine (**Figure K**).

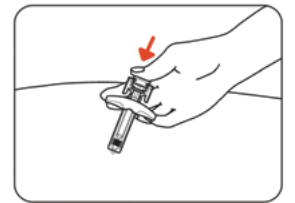
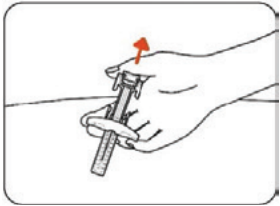

Figure K

## Step 11: Release the plunger head

Slowly release the plunger head by lifting your thumb. After a complete injection, the needle guard will cover the needle and you may hear a click (**Figure L**).

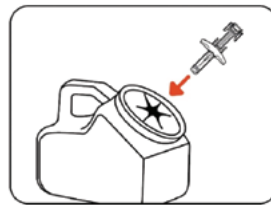

**Figure L**

## Step 12: Throw away (dispose of) the used ZILBRYSQ prefilled syringe

Throw away (dispose of) the used ZILBRYSQ prefilled syringe into a sharps disposal container (**Figure M**) right away.

**Do not** throw away (dispose of) the ZILBRYSQ prefilled syringe in your household trash.



**Figure M**

If you do not have an FDA-cleared sharps disposal container, you may use a household container that is:

- made of a heavy-duty plastic,
- can be closed with a tight-fitting, puncture-resistant lid, without sharps being able to come out,
- upright and stable during use,
- leak-resistant, and
- properly labelled to warn of hazardous waste inside the container.

**Do not** throw away (dispose of) your used sharps disposal container in your household trash unless your community guidelines permit this.

**Do not** recycle your used sharps disposal container.

Always keep the sharps disposal container out of the reach of children.

**Note:** When your sharps disposal container is almost full, you will need to follow your community guidelines for the right way to dispose of your sharps disposal container. There may be state or local laws about how you should throw away your used needles and syringes. For more information about safe sharps disposal, and for specific information about sharps disposal in the state you live in, go to the FDA's website at: <http://www.fda.gov/safesharpsdisposal>.

## Step 13: Examine the injection site

Press a cotton ball or gauze pad over the injection site and hold it for 10 seconds (**Figure N**).

**Do not** rub the injection site. You may have slight bleeding. This is normal. Apply an adhesive bandage if needed (**Figure O**).

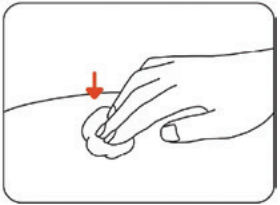

**Figure N**

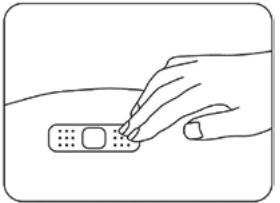

**Figure O**



The injection is complete.



For more information or help, contact your healthcare provider.

If you have any questions, call UCBCares at

**1-844-599-CARE (2273)**

or visit

**[www.AskUCBCares.com](http://www.AskUCBCares.com)**

Manufactured for: UCB, Inc. Smyrna, GA 30080

## **IMPORTANT SAFETY INFORMATION INCLUDING BOXED WARNING**

**ZILBRYSQ is a medicine that affects part of your immune system. ZILBRYSQ may lower the ability of your immune system to fight certain infections.** ZILBRYSQ increases your chance of getting serious and life-threatening meningococcal infections. Meningococcal infections may become life-threatening or fatal if not recognized and treated early. You must complete or update two types of meningococcal vaccines (for both serogroup B infections and serogroup A, C, W, and Y infections) at least 2 weeks before your first dose of ZILBRYSQ if you have not already had these vaccines. If your healthcare provider decided that urgent treatment with ZILBRYSQ is needed, you should receive meningococcal vaccination(s) as soon as possible. If you have not completed or updated vaccinations for meningococcal infections at least 2 weeks before your first ZILBRYSQ dose and ZILBRYSQ therapy must be started right away, you must also receive antibiotics. If you had a meningococcal vaccine in the past,

you might need additional vaccination before starting ZILBRYSQ. Your healthcare provider will decide if you need additional meningococcal vaccination. Meningococcal vaccines do not prevent all meningococcal infections. **Call your healthcare provider or get emergency medical care right away if you get any of these signs and symptoms of a meningococcal infection:** headache with nausea or vomiting, headache and fever, headache with a stiff neck or stiff back, fever, fever and a rash, confusion, muscle aches with flu-like symptoms, and eyes sensitive to light.

**Your healthcare provider will give you a Patient Safety Card about the risk of meningococcal infection.** Carry it with you at all times during treatment and for 2 months after your last ZILBRYSQ dose. Your risk of meningococcal infection may continue for several weeks after your last dose of ZILBRYSQ. It is important to show this card to any healthcare provider who treats you. This will help them diagnose and treat you quickly. **ZILBRYSQ is only available through a program called the ZILBRYSQ REMS.** Before

you can receive ZILBRYSQ, your healthcare provider must: enroll in the ZILBRYSQ REMS; counsel you about the risk of meningococcal infection; give you the Patient Guide, including information about the signs and symptoms of meningococcal infection; give you a **Patient Safety Card** about your risk of meningococcal infection, as discussed above; make sure that you are vaccinated with two types of meningococcal vaccines and, if needed, get revaccinated with the meningococcal vaccines. Ask your healthcare provider if you are not sure if you need to be revaccinated.

**ZILBRYSQ may also increase the risk of other types of serious infections.**

ZILBRYSQ may increase your chance of getting *Streptococcus pneumoniae* and *Haemophilus influenzae type b*. Your healthcare provider will tell you if you should receive the *Streptococcus pneumoniae* and *Haemophilus influenzae type b* vaccinations. Certain people may have an increased risk of gonorrhea infection. Talk to your healthcare

provider about whether you are at risk for gonorrhea infection, about gonorrhea prevention, and about regular testing. Call your healthcare provider right away if you have new signs or symptoms of infection.

**Do not use ZILBRYSQ if you** have a *Neisseria meningitidis* infection.

**Before you use ZILBRYSQ, tell your healthcare provider about all of your medical conditions, including if you** have an infection or fever; are pregnant or plan to become pregnant; or are breastfeeding or plan to breastfeed. **Tell your healthcare provider about all the medicines you take,** including prescription and over-the-counter medicines, vitamins, and herbal supplements.

**In addition to increasing your chance of getting serious meningococcal infections, ZILBRYSQ may also cause inflammation of the pancreas (pancreatitis) and other pancreatic problems.** Pancreatitis and pancreatic cysts have happened in people who use ZILBRYSQ. Your healthcare

provider will do blood tests to check your pancreas before you start treatment with ZILBRYSQ. **Call your healthcare provider right away** if you have pain in your stomach area (abdomen) that will not go away. Your healthcare provider will tell you if you should stop using ZILBRYSQ. The pain may be severe or felt going from your abdomen to your back. The pain may happen with or without vomiting. These may be symptoms of pancreatitis.

**The most common side effects of ZILBRYSQ include** injection site reactions, upper respiratory tract infections, and diarrhea.

Tell your healthcare provider about any side effect that bothers you or that does not go away.

These are not all the possible side effects of ZILBRYSQ. For more information, ask your healthcare provider or pharmacist. Call your doctor for medical advice about side effects. You may report side effects to FDA at [www.fda.gov/medwatch](http://www.fda.gov/medwatch) or 1-800-FDA-1088. You may also report side

effects to UCB, Inc. by calling 1-844-599-CARE [2273].

**See the detailed Instructions for Use that comes with ZILBRYSQ for information on how to prepare and inject a dose of ZILBRYSQ, and how to properly throw away (dispose of) used ZILBRYSQ prefilled syringes.**

ZILBRYSQ is a prescription medicine used to treat adults with a disease called generalized myasthenia gravis (gMG) who are anti-acetylcholine receptor (AChR) antibody positive. It is not known if ZILBRYSQ is safe and effective in children.

Please see the full Prescribing Information and Medication Guide for ZILBRYSQ, including the Boxed Warning regarding serious meningococcal infections. Please see the Instructions for Use for the ZILBRYSQ Single-Dose Prefilled Syringe. Talk to your healthcare provider about your condition or your treatment. For more information, go to [www.ZILBRYSQ.com](http://www.ZILBRYSQ.com) or call 1-844-599-2273.

**ZILBRYSQ<sup>®</sup>**  
(zilucoplan) Injection

**Step-by-Step  
Injection Guide**

**Scan the code for more information on  
ZILBRYSQ patient support.**



Inspired by **patients.**  
Driven by **science.**

ZILBRYSQ<sup>®</sup> is a registered trademark, and ONWARD<sup>™</sup> is a trademark, of the UCB Group of Companies.  
©2024 UCB, Inc., Smyrna, GA 30080. All rights reserved. US-ZL-2300035